



Ontwerp- en
Productie-
Technologie

Rondleiding

scan
of klik de
qr-codes!



odisee.be/OPT

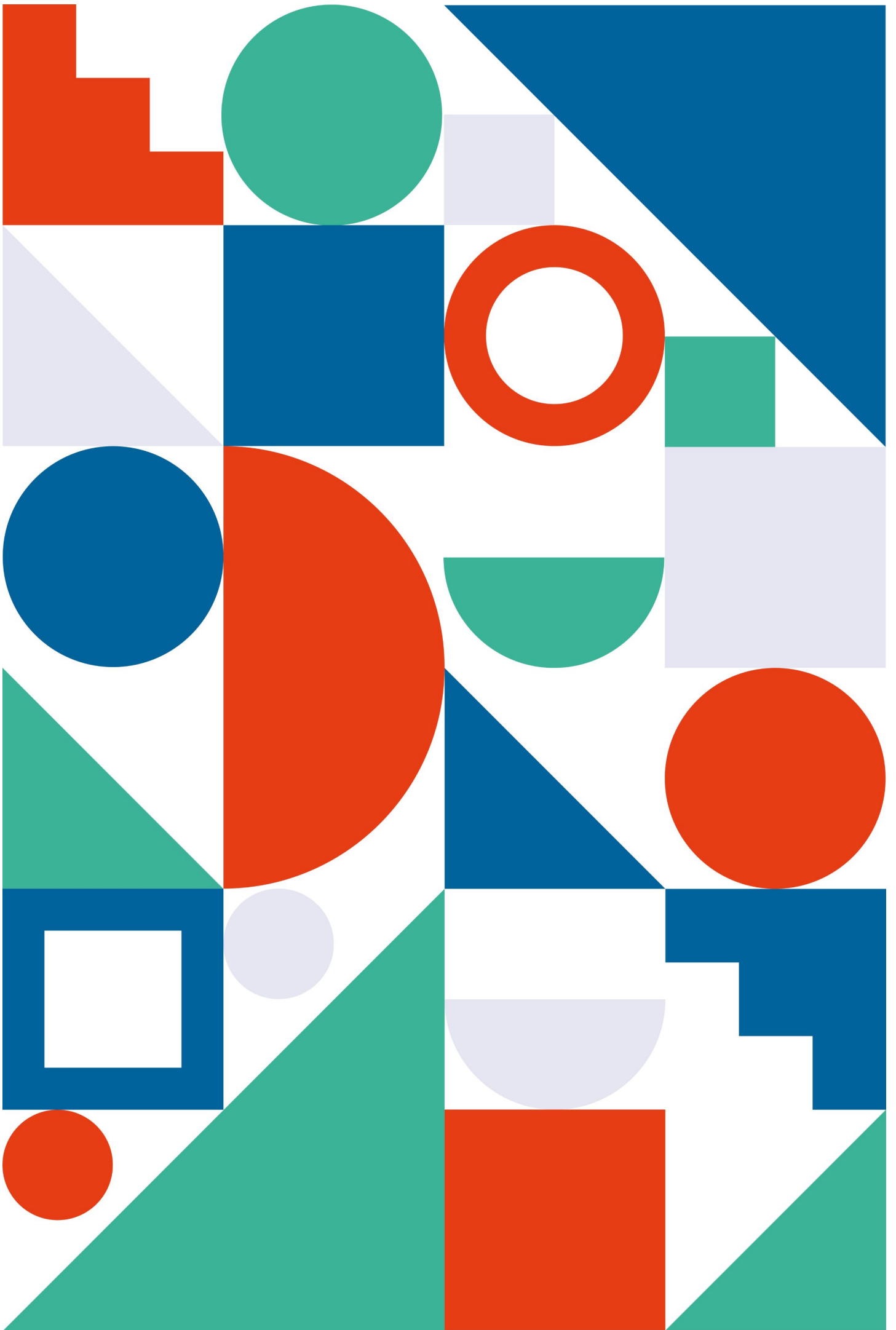

Statica

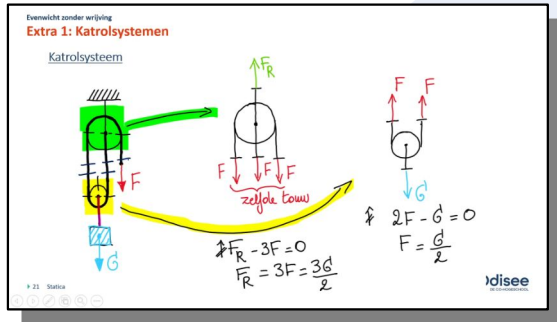

AutoCAD Basisinleiding

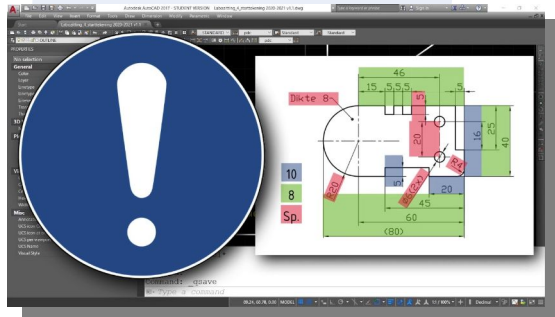

Office Software



1^e fase
1^e sem.



1^e fase
1^e sem.



Kinetica



PL3EbfoEGIpI8QXNVPo1ugZjDBIFwh15Gb

Toegepaste Mechanica 1



PL3EbfoEGIpI-KAKdOdssZCMNjRxJ9GkrN

Lastechnologie

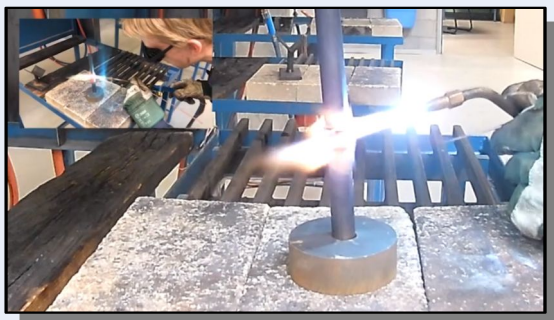

PL3EbfoEGIpI9AHCgR8UHP76tuxiz3109N

1^e fase
2^e sem.

OPT Maakweek

2018

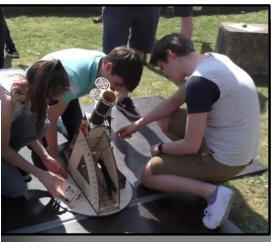

PL3EbfoEGlpl9W7EST-MPhoHgVrynmcyf

2019



PL3EbfoEGlpl-1mvAzXjsdjaTxlrp73Kpx

2020



PL3EbfoEGlpl9YFWPSZ5QCkzLN4_ocvOEq

www.odisee.be / OPT Maakweek



2021: "rubber band plane"



PL3EbfoEGlpl9Wz3o9E5MoCrZVnvoQReX3

2022



PL3EbfoEGlpl-e4yX3Er6jzcrzTA34R2dG



PL3EbfoEGlpl-8bZNbmgRgvauZ1ffD10Az



CAD, lasersnijden instructievideo's

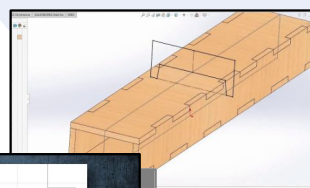

PL3EbfoEGlpl8A0MF3PLo-4tvYCr0JHL6k

1^e fase
2^e sem.

Projecten 1



PL3EbfoEGlpI9fJzVQys8jPppZaGd8wUBZ

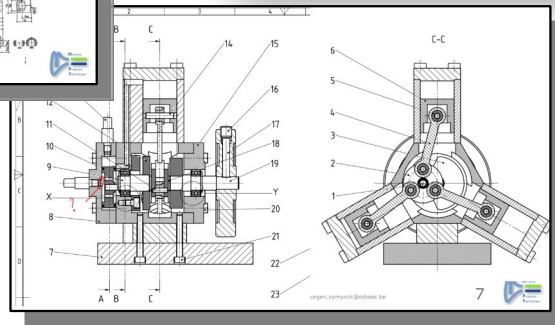
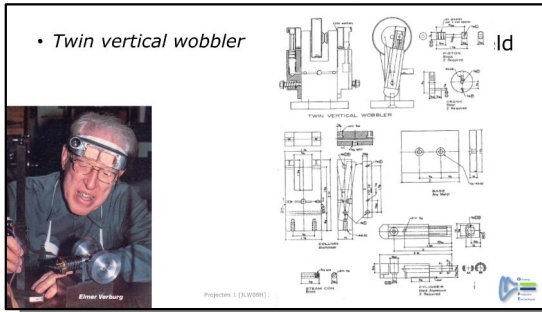

3DEXPERIENCE®

OPT/EMS Lastechnologie



PL3EbfoEGlpI9AhCgR8UHP76tuxiz3109N



2^e fase
1^e sem.

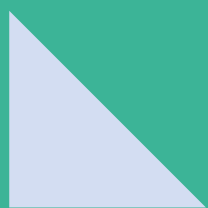

2^e fase
1^e sem.



CAD+

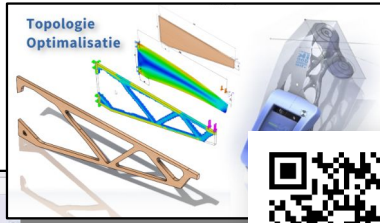

PL3EbfoEGlpl_IW8kFAOwzPhJTAninDhep

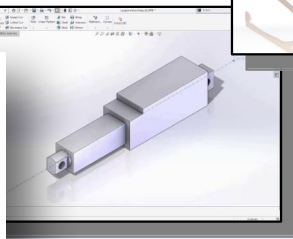

PL3EbfoEGlpl8t1SzN2Aq8RomqhChLGT5N



3DEXPERIENCE®

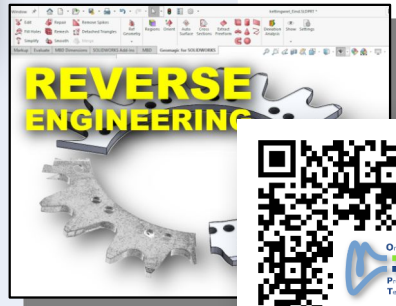

PL3EbfoEGlpl-u8-fq2wNrrY6vBbkDnoyb

Projecten 2

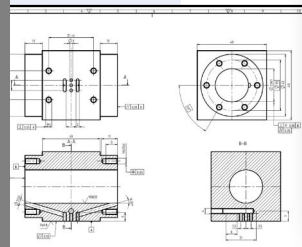
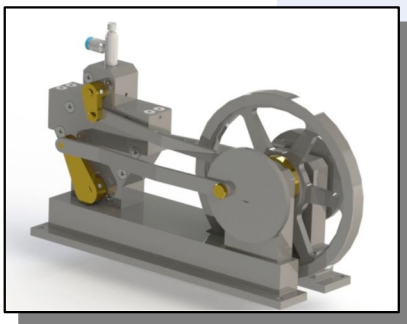

PL3EbfoEGlpl8E9iCeysrcJjkkKM-NBz

Ontwerpen 4

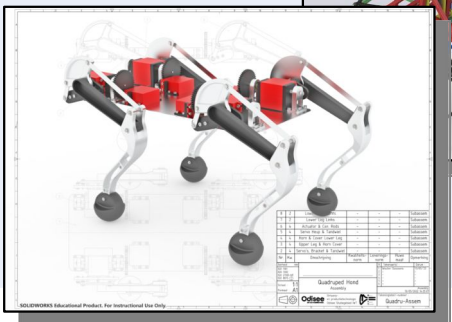
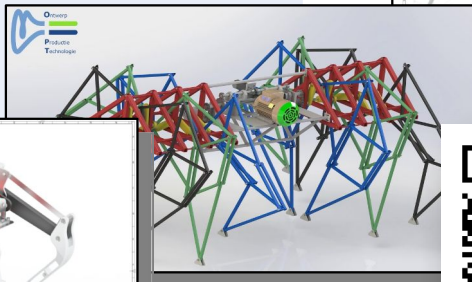

PL3EbfoEGlpl8lPaJVAp2ROQcgYUJgyf6P

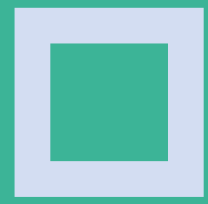

2^e fase
2^e sem.

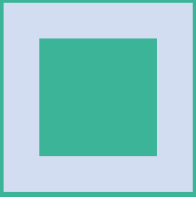

2^e fase
2^e sem.

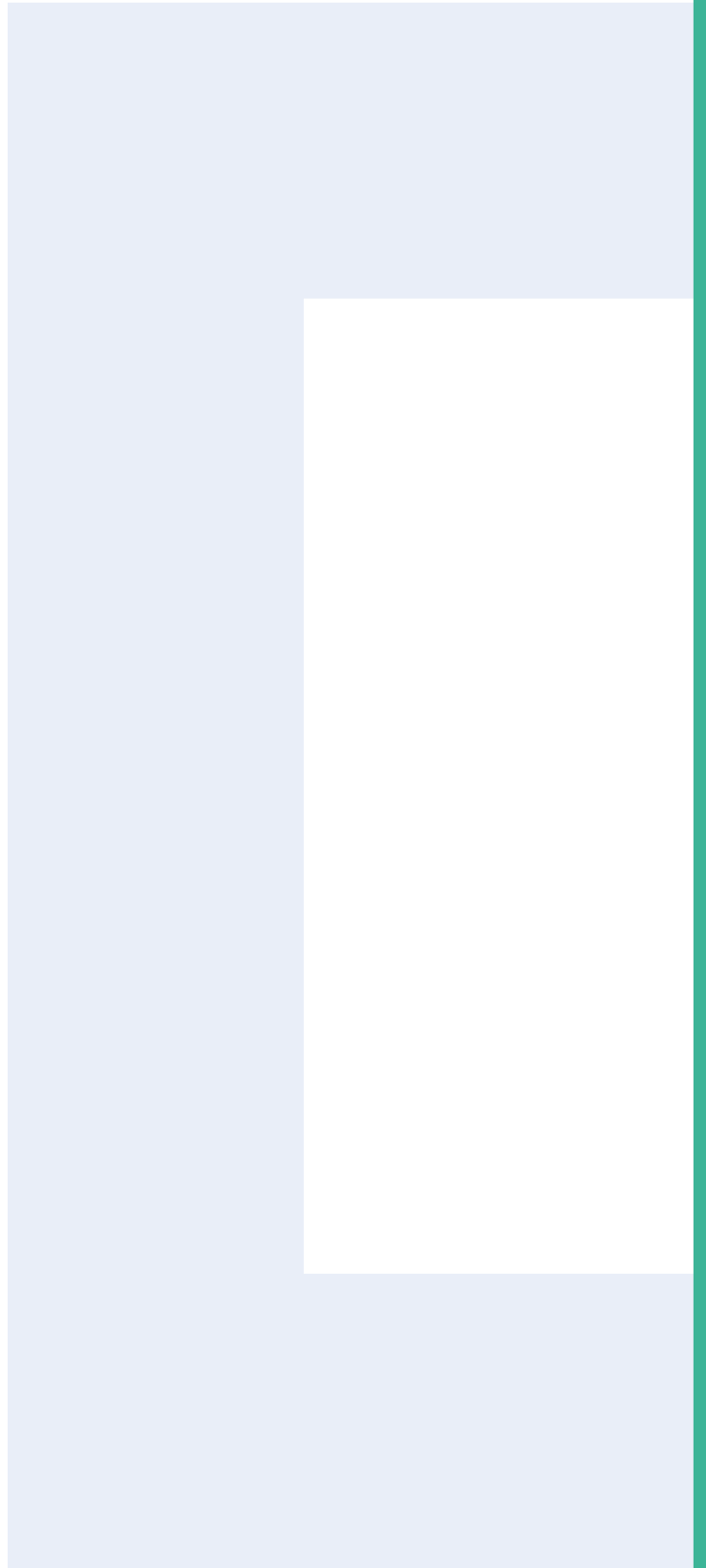

Projecten 3

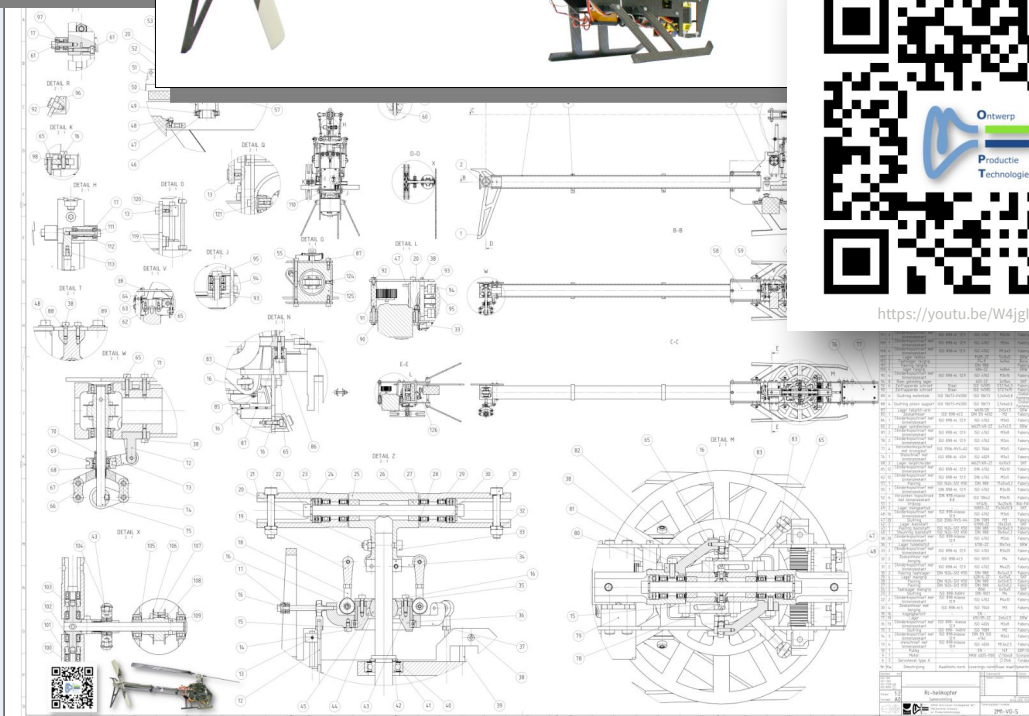
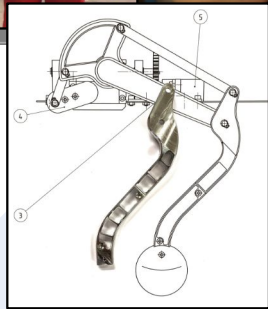
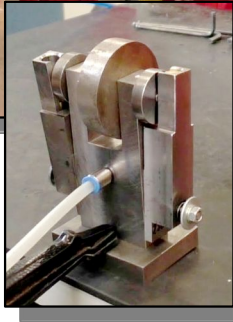

3^e fase
1^e sem.

Stage, Erasmus & Bachelorproef

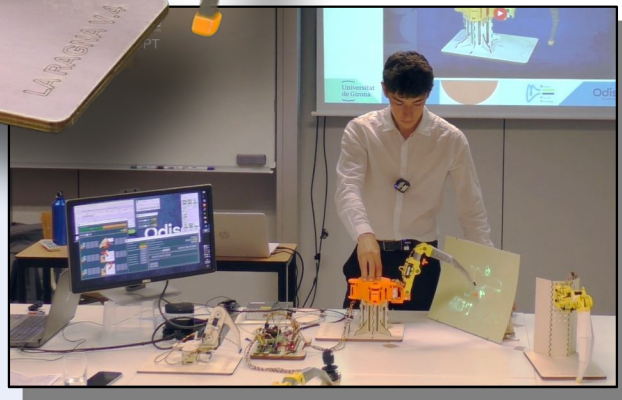
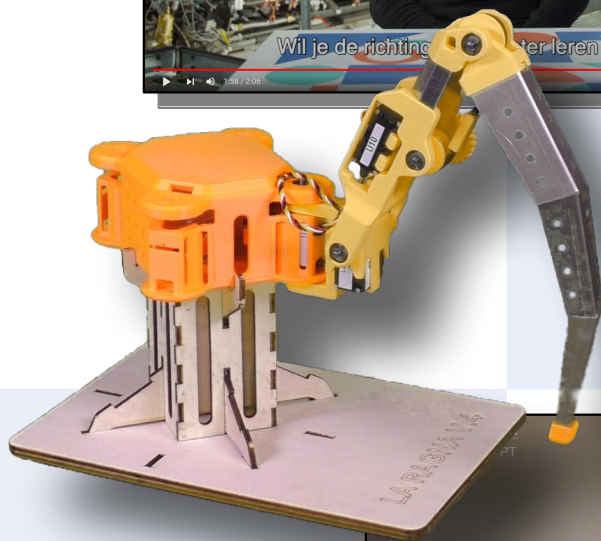
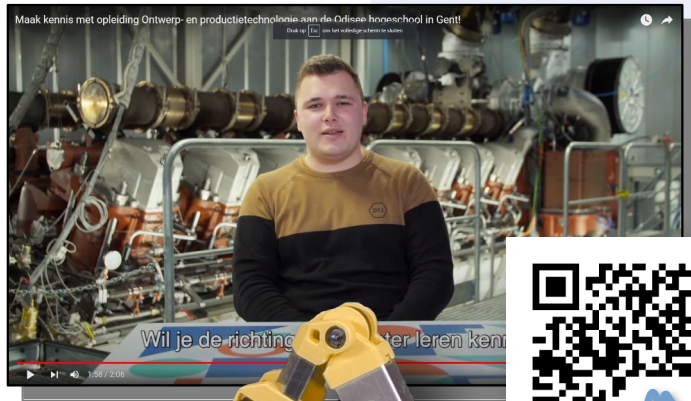

3^e fase
2^e sem.

Afstuderen!

3^e fase
2^e sem.

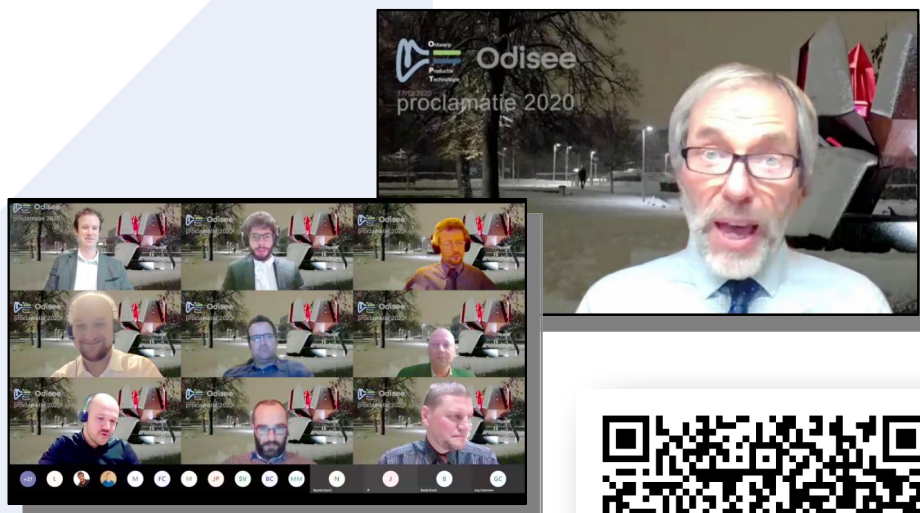

PL3EbfoEGlpI-KlxHsviksBecqILfkz_Jv



Lessen



Studenten



Machinepark



Projecten



Events



Topvideo's



